

DS-1200KI/DS-1006KI
Keyboard

User Manual

UD03129N

About this Manual

This Manual is applicable to DS-1200KI/1006KI Keyboard.

The Manual includes instructions for using and managing the product. Pictures, charts, images and all other information hereinafter are for description and explanation only. The information contained in the Manual is subject to change, without notice, due to firmware updates or other reasons. Please find the latest version in the company website

Please use this user manual under the guidance of professionals.

Legal Disclaimer

REGARDING TO THE PRODUCT WITH INTERNET ACCESS, THE USE OF PRODUCT SHALL BE WHOLLY AT YOUR OWN RISKS. OUR COMPANY SHALL NOT TAKE ANY RESPONSIBILITIES FOR ABNORMAL OPERATION, PRIVACY LEAKAGE OR OTHER DAMAGES RESULTING FROM CYBER ATTACK, HACKER ATTACK, VIRUS INSPECTION, OR OTHER INTERNET SECURITY RISKS; HOWEVER, OUR COMPANY WILL PROVIDE TIMELY TECHNICAL SUPPORT IF REQUIRED.

SURVEILLANCE LAWS VARY BY JURISDICTION. PLEASE CHECK ALL RELEVANT LAWS IN YOUR JURISDICTION BEFORE USING THIS PRODUCT IN ORDER TO ENSURE THAT YOUR USE CONFORMS THE APPLICABLE LAW. OUR COMPANY SHALL NOT BE LIABLE IN THE EVENT THAT THIS PRODUCT IS USED WITH ILLEGITIMATE PURPOSES.

IN THE EVENT OF ANY CONFLICTS BETWEEN THIS MANUAL AND THE APPLICABLE LAW, THE LATER PREVAILS.

Regulatory Information

FCC information

FCC compliance: This equipment has been tested and found to comply with the limits for a digital device, pursuant to part 15 of the FCC Rules. These limits are designed to provide reasonable protection against harmful interference when the equipment is operated in a commercial environment. This equipment generates, uses, and can radiate radio frequency energy and, if not installed and used in accordance with the instruction manual, may cause harmful interference to radio communications. Operation of this equipment in a residential area is likely to cause harmful interference in which case the user will be required to correct the interference at his own expense.

FCC conditions

This device complies with part 15 of the FCC Rules. Operation is subject to the following two conditions:

1. This device may not cause harmful interference.
2. This device must accept any interference received, including interference that may cause undesired operation.

EU Conformity Statement



This product and - if applicable - the supplied accessories too are marked with "CE" and comply therefore with the applicable harmonized European standards listed under the Low Voltage Directive 2006/95/EC, the EMC Directive 2004/108/EC, the RoHS Directive 2011/65/EU.



2012/19/EU (WEEE directive): Products marked with this symbol cannot be disposed of as unsorted municipal waste in the European Union. For proper recycling, return this product to your local supplier upon the purchase of equivalent new equipment, or dispose of it at designated collection points. For more information see: www.recyclethis.info.



2006/66/EC (battery directive): This product contains a battery that cannot be disposed of as unsorted municipal waste in the European Union. See the product documentation for specific battery information. The battery is marked with this symbol, which may include lettering to indicate cadmium (Cd), lead (Pb), or mercury (Hg). For proper recycling, return the battery to your supplier or to a designated collection point. For more information see: www.recyclethis.info.

Safety Instructions

- Proper configuration of all passwords and other security settings is the responsibility of the installer and/or end-user.
- In the use of the product, you must be in strict compliance with the electrical safety regulations of the nation and region. Please refer to technical specifications for detailed information.
- Input voltage should meet both the SELV (Safety Extra Low Voltage) and the Limited Power Source with 12 VDC according to the IEC60950-1 standard. Please refer to technical specifications for detailed information.
- Do not connect several devices to one power adapter as adapter overload may cause overheating or a fire hazard.
- Please make sure that the plug is firmly connected to the power socket.
- If smoke, odor or noise rise from the device, turn off the power at once and unplug the power cable, and then please contact the service center.

Preventive and Cautionary Tips

Before connecting and operating your device, be advised of the following tips:

- Ensure unit is installed in a well-ventilated, dust-free environment.
- Unit is designed for indoor use only.
- Keep all liquids away from the device.
- Ensure environmental conditions meet factory specifications.
- Ensure unit is properly secured to a rack or shelf. Major shocks or jolts to the unit as a result of dropping it may cause damage to the sensitive electronics within the unit.
- Use the device in conjunction with an UPS if possible.
- Power down the unit before connecting and disconnecting accessories and peripherals.
- Improper use or replacement of the battery may result in explosion. Replace with the same or equivalent type only. Dispose of used batteries according to the instructions provided by the battery manufacturer.

Symbol Conventions

The symbols that may be found in this document are defined as follows.



Symbol	Description
 NOTE	Provides additional information to emphasize or supplement important points of the main text.
 WARNING	Indicates a potentially hazardous situation, which if not avoided, could result in equipment damage, data loss, performance degradation, or unexpected results.
 DANGER	Indicates a hazard with a high level of risk, which if not avoided, will result in death or serious injury.

Table of Contents

Chapter 1 Overview.....	1
1.1 Features.....	1
1.2 Appearance	2
1.3 Interfaces and Joystick	2
1.4 Functional Buttons	4
Chapter 2 Getting Started	7
2.1 Activating Your Device.....	7
2.2 Logging in	7
2.3 System Menu.....	9
Chapter 3 Basic Configuration	10
3.1 Network Access Settings	10
3.2 Device Mangement	10
3.2.1 Managing Devices by Web Browser.....	10
3.2.2 Managing Input/Output Channels	12
3.3 User and User-related Device Management.....	13
Chapter 4 Keyboard Operation.....	15
4.1 Keyboard Operation	16
4.1.1 Video Wall Control	16
4.1.2 Preset/Patrol/Pattern Calling	17
4.1.3 Scene Calling	18
4.1.4 AUX Functions	18
4.2 MAG by IP.....	20
4.3 DVR by IP	21
4.4 MAG by RS-422	22
4.5 DVR by RS-485.....	23
4.6 Dome by RS-485.....	24
4.7 Shortcut Operation	25
Chapter 5 System Menu Configuration.....	26
5.2 Version.....	26
5.3 User Management	26
5.4 RS-485/RS-422 Settings.....	27
5.5 Hardware.....	27
5.6 Time Settings.....	28

5.7 Maintenance	28
Chapter 6 Specifications	29

Chapter 1 Overview

1.1 Features

- 128 x 64 screen
- 4-axis joystick
- Accessible to the Multi-functional Video Center (MVC), Matrix Access Gateway (VAG), Video Wall Controller, Decoder, etc.; and shortcut operation of camera/camera groups switch on video wall
- Connectable to dome and realize PTZ control and picture capture by joystick operation
- Accessible to DVR via network or serial port, and operation of front panel buttons.
- 16 user accounts management: 1 admin and 15 operators
- System upgrade and import / export of configuration files by USB-flash disk
- Captured pictures(FAT32) can be stored in U-flash disk
- DS-1200KI keyboard: network access and configuration by Web browser support; and up to 1000 devices can be managed in the keyboard operation mode
- DS-1006KI keyboard: connect to devices by RS-485/422 serial port.

1.2 Appearance

Refer to Figure 1-1 for the appearance of the keyboard.



Figure 1-1 Keyboard Appearance

1.3 Interfaces and Joystick

Refer to Figure 1-2 for the interfaces and joystick of the keyboard.

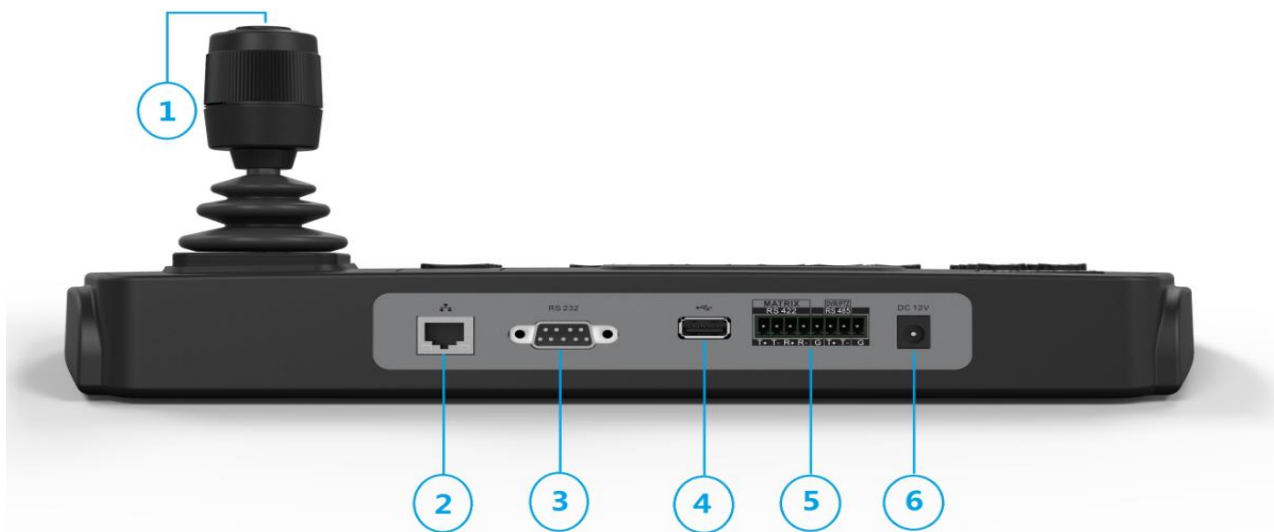

Figure 1-2 Interfaces

Table 1-1 Description of Rear Panel

SN	Item	Description
1	4-axis joystick	<ul style="list-style-type: none"> ● In menu mode, Move to up/down to select the menu for configuration Move to left/right to select items in menu. When entering the value in the field, move to the left to clear the previous character. Press the central button to confirm the enter is used as Enter button. ● In shortcut operation mode, Move the joystick to realize pan/tilt movement in 8 directions. And the PTZ speed is depending on the joystick movement range. Rotate the joystick in clockwise/anti-clockwise directions to realize the zoom in/out control. Press the central button to capture picture.
2	LAN (for DS-1200KI only)	10/100 Mbps Ethernet interface
3	RS-232 serial interface	Serial interface for debugging
4	USB interface	Universal Serial Bus (USB) port for additional devices such as USB-flash disk
5	RS-422 serial interface	Connect with the matrix, video access gateway device, etc.
	RS-485 serial interface	Connect with the speed dome unit for PTZ control
4	Power supply	12 VDC power input

1.4 Functional Buttons

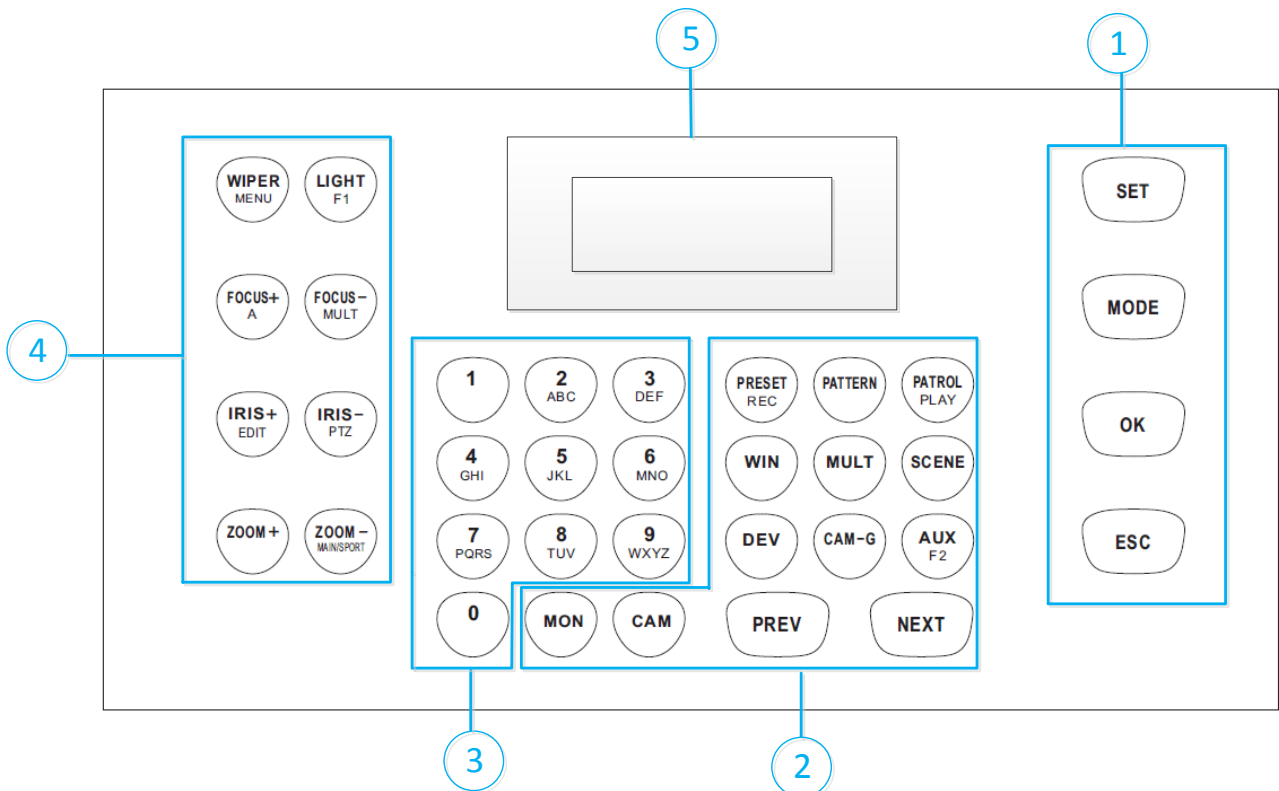

Figure 1-3 Functional Buttons

Table 1-2 Description of Rear Panel

SN	Item	Button	Description
1	Common Buttons	SET	Enter the main menu of the system.
		MODE	Enter the 6 operation modes interface.
		OK	Confirm the selection and operation.
		ESC	Cancel and back to the pervious menu.
	Video Wall Control	MON	In the shortcut operation mode, use with the numeric buttons to select the monitor.
		CAM	In the shortcut operation mode, use with the numeric buttons to select the camera.
		RRESET/REC	Use with the numeric buttons to call the preset.
		PATTERN	<ul style="list-style-type: none"> Press <i>PATTERN</i> directly or <i>0 + PATTERN</i> to call the auto scanning. Use with the numeric (>0) buttons to call the pattern.

		PATROL/PLAY	<ul style="list-style-type: none"> ● Use with the numeric buttons to call the patrol. ● Start playing the video files in DVR operation mode.
		WIN	In the shortcut operation mode, use with the numeric buttons to select window of video wall.
		MULT	In the shortcut operation mode, use with the numeric buttons to select the window division modes of video wall.
		SCENE	In the shortcut operation mode, use with the numeric buttons to switch the scenes.
		DEV	Use with the numeric buttons to select the device ID.
		CAM-G	In the shortcut operation mode, use with the numeric buttons to select the camera group.
		AUX/F2	Realize the defined auxiliary functions (picture capture or screen jointing of video wall)
		PREV	In the shortcut operation mode, switch to the previous camera ID or camera group ID.
		NEXT	In the shortcut operation mode, switch to the next camera ID or camera group ID.
3	Alphanumeric Buttons	0-9/A-Z	Inputs numbers and characters in edit mode.
4	PTZ Control/ DVR Control	WIPER/ MENU	<ul style="list-style-type: none"> ● In PTZ control mode, turn on/off the wiper. ● In DVR operation mode, enter the main menu of DVR.
		LIGHT/F1	<ul style="list-style-type: none"> ● In PTZ control mode, turn on/off the light. ● In DVR operation mode, the same with the F1 button on the DVR panel.
		FOCUS+/A	<ul style="list-style-type: none"> ● In PTZ control mode, operate the focus far. ● In DVR operation mode, the same with the A button on the DVR panel. ● In edit mode, switch the character input mode: numerals (123), upper case (ABC) and lower case (abc).

		FOCUS-/MULT	<ul style="list-style-type: none">● In PTZ control mode, operate the focus near.● In DVR operation mode, the same with the MULT button on the DVR panel.
		IRIS+/EDIT	<ul style="list-style-type: none">● In PTZ control mode, operate the iris open.● In DVR operation mode, the same with the EDIT button on the DVR panel.
		IRIS-/PTZ	<ul style="list-style-type: none">● In PTZ control mode, operate the iris close.● In DVR operation mode, the same with the PTZ button on the DVR panel.
		ZOOM+	In PTZ control mode, operate the zoom in.
		ZOOM- MAIN/SPOT	<ul style="list-style-type: none">● In PTZ control mode, operate the zoom out.● In DVR operation mode, the same with the MAIN/SPOT button on the DVR panel.
5	LCD Display		128 x 64 pixel screen for display of menu.

Chapter 2 Getting Started

2.1 Activating Your Device

Purpose:

For the first-time access, you need to activate the device by setting an admin password. No operation is allowed before activation. You can also activate the device via SADP as well.

Step 1 In the Device Activation interface, enter the admin passwords in the text field of **Admin Password** and **Confirm**.



NOTE

In edit mode, you can press the FOCUS+/A button on the keyboard panel to switch the character input mode: numerals (123), upper case (ABC) and lower case (abc).

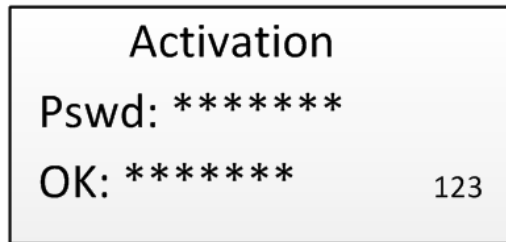

Figure 2-1 Activation Interface



WARNING

STRONG PASSWORD RECOMMENDED—We highly recommend that you create a strong password of your own choosing (8 characters, including upper case letters, lower case letters, numbers, and special characters) in order to increase the security of your product. And we recommend that you reset your password regularly, especially in the high security system, resetting the password monthly or weekly can better protect your product.

Step 2 Click **Confirm** to finish the device activation.



NOTE

When the device is activated, you need to adjust the date and time settings.

2.2 Logging in

Purpose:

You must log in to the device before configuring the keyboard, and operating the menu and other functions. Local login and remote login (by Web browser) are optional.

Local Login

Step 1 In the Login interface, enter the user name in the User Name field.

Step 2 Enter the password in the Password field.

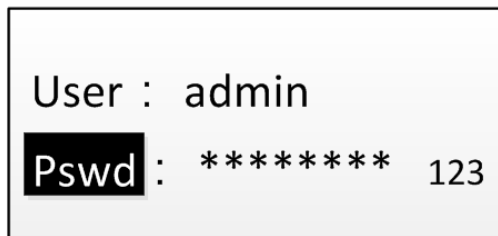

Figure 2-2 Login Interface

Step 3 Press the **OK** button to log in to the device.

NOTE

In the Login dialog box, if you enter the wrong password 7 times for admin user or 5 times for operators, the current user account will be locked for 30 minutes.

Remote Login (via Web browser)

Step 1 Open the web browser, and enter the address (**https://IP address**) to enter the device login page.



Figure 2-3 Login Interface

Step 2 Enter the user name and password in the field.

Step 3 Click **Login** to log in to the device.

2.3 System Menu

After login, you enter the system menu for configuration and operation.

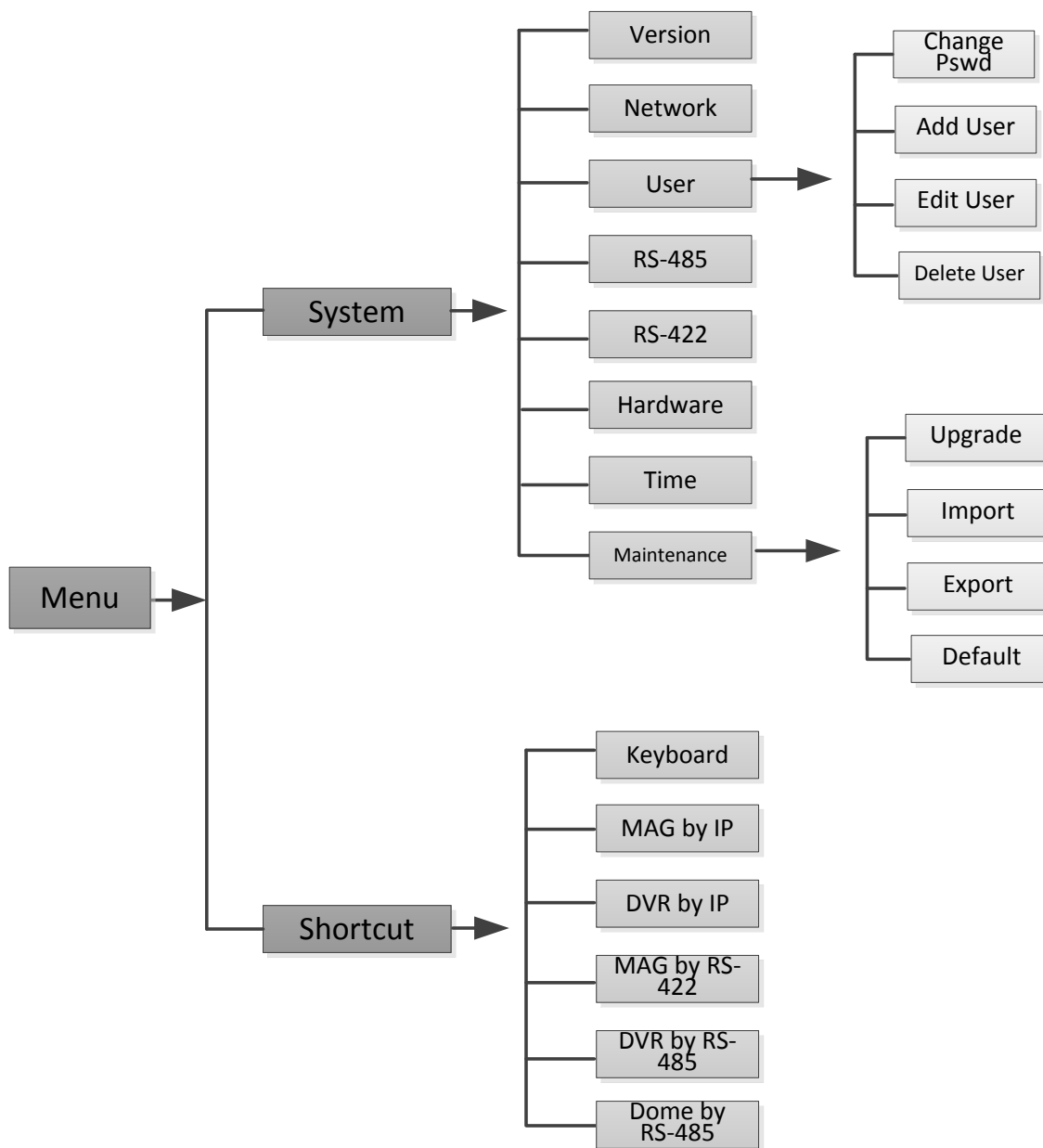

Figure 2-4 System Menu

Chapter 3 Basic Configuration

3.1 Network Access Settings



You shall acknowledge that the use of the product with the Internet access might be under network security risks. For avoidance of any network attacks and information leakage, please strengthen your own protection. If the product does not work properly, contact with your dealer or the nearest service center.



The network connection is provided by the DS-1200KI keyboard only.

Step 1 On the keyboard, enter the network settings menu

System>Network

Step 2 Use the joystick to set the DHCP **OFF** or **ON** (is supported in the network).

Step 3 If you set the DHCP to OFF, continue to set the network parameters, including the IP Address, Gateway and Subnet Mask.

Step 4 Press **OK** to save the settings.

3.2 Device Mangement

3.2.1 Managing Devices by Web Browser

Purpose:

You must add the devices to the keyboard via Web browser before realizing the operation and control of the devices on the keyboard.

Step 1 Log in to the device.

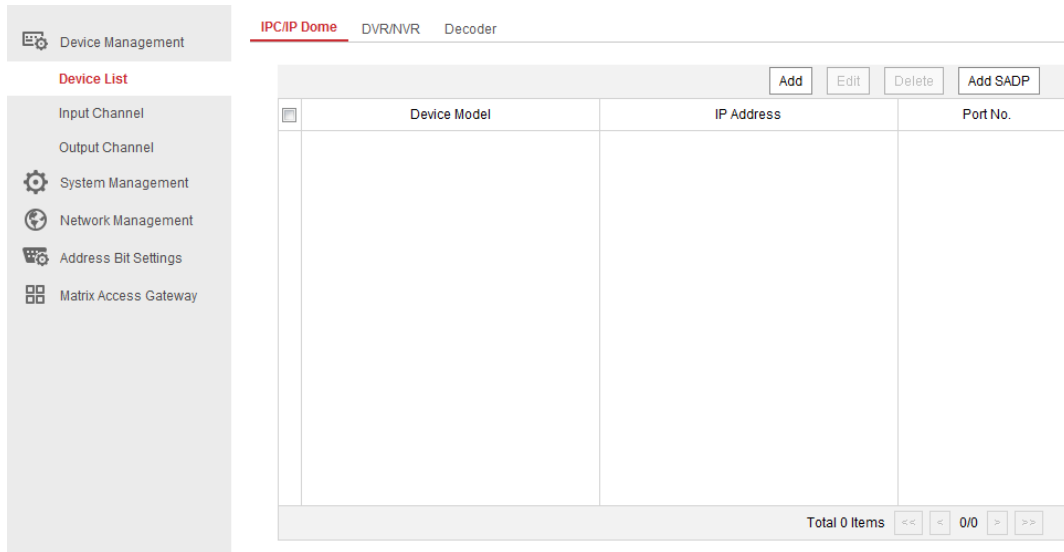

Figure 3-1 Device Management Interface

Step 2 On the Device Management > Device List page, select a device type (IPC/IP Dome, DVR/NVR or Decoder) and click **Add** to add the devices.

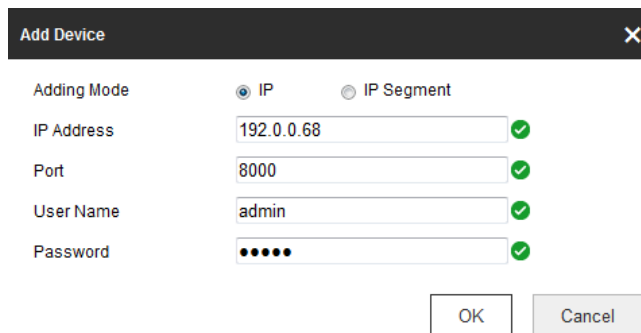

Figure 3-2 Add Device

Step 3 You can add the device by IP or by IP segment. Enter the network parameters, including the IP address, port, login user name and password.

Step 4 Click **OK** to save the settings. The successfully added device is shown in the list.



Figure 3-3 Successfully Added Device

 **NOTE**

You can also click the **Add SADP** to add the online devices in the same network segment.

3.2.2 Managing Input/Output Channels

Purpose:

You can manage the import and export of input channels in batch, input group and output channels via Web browser.

Importing and Exporting Input Channel List

Step 1 Enter the Device Management > Input Channel > Input List page.

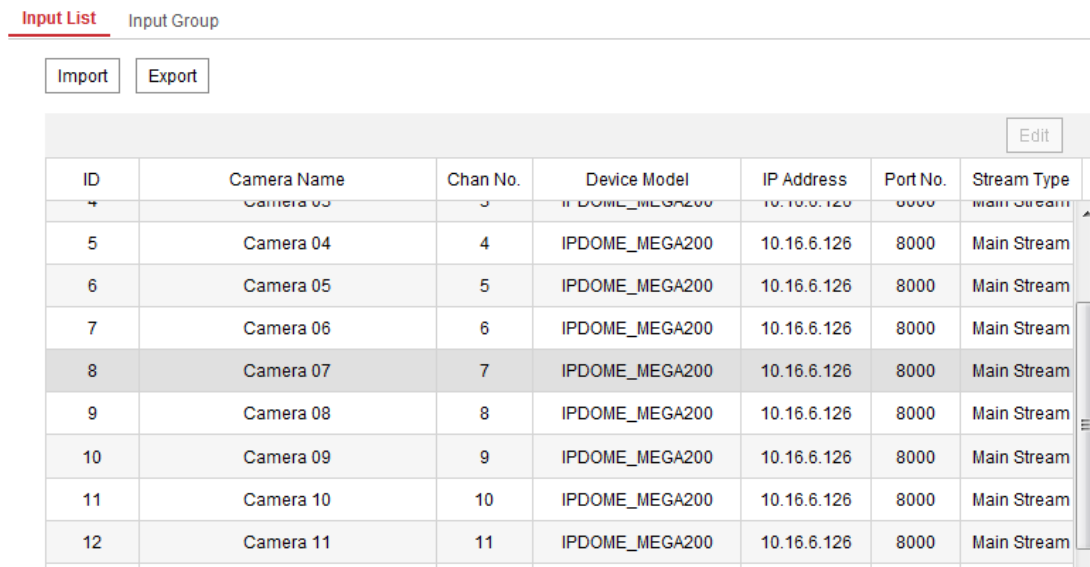

The screenshot shows the 'Input List' page with a table of input channels. The table has the following columns: ID, Camera Name, Chan No., Device Model, IP Address, Port No., and Stream Type. The rows are numbered 4 through 12. The 'Stream Type' for all entries is 'Main Stream'. The 'Device Model' for all entries is 'IPDOME_MEGA200'. The 'IP Address' for all entries is '10.16.6.126'. The 'Port No.' for all entries is '8000'. There are buttons for 'Import', 'Export', and 'Edit' at the top of the table.

ID	Camera Name	Chan No.	Device Model	IP Address	Port No.	Stream Type
4	Camera 03	3	IPDOME_MEGA200	10.16.6.126	8000	Main Stream
5	Camera 04	4	IPDOME_MEGA200	10.16.6.126	8000	Main Stream
6	Camera 05	5	IPDOME_MEGA200	10.16.6.126	8000	Main Stream
7	Camera 06	6	IPDOME_MEGA200	10.16.6.126	8000	Main Stream
8	Camera 07	7	IPDOME_MEGA200	10.16.6.126	8000	Main Stream
9	Camera 08	8	IPDOME_MEGA200	10.16.6.126	8000	Main Stream
10	Camera 09	9	IPDOME_MEGA200	10.16.6.126	8000	Main Stream
11	Camera 10	10	IPDOME_MEGA200	10.16.6.126	8000	Main Stream
12	Camera 11	11	IPDOME_MEGA200	10.16.6.126	8000	Main Stream

Figure 3-4 Import & Export of Input List

Step 2 (optional) You can select an input channel from the list and click **Edit** to edit the parameters including the input channel ID, camera name and stream type.

Step 3 Click the **Export** button to export the input channel list (in excel) to the local directory.

Click the **Import** button to import the input channel list (in excel) from the local directory.

Managing Input Channel Group

Step 1 Enter the Device Management > Input Channel> Input Group page.

Step 2 Click **Add Group** to enter the Add Input Group page.

Step 3 Edit the group name, set the auto-switch interval (10-10000 sec) and select the input channels from the list to the group.



NOTE

Up to 16 input groups can be added.

Input List Input Group

Group ID: 1 Name Auto-Switch: 20s

ID	Camera Name	Chan No.	Device Model	IP Address	Port No.	Stream Type
1	IPdome	1	DS-6416HD-T	10.65.199.176	8000	Main Strea
2	Camera 01	1	IPDOME_MEGA200	10.16.6.126	8000	Main Strea
3	Camera 02	2	IPDOME_MEGA200	10.16.6.126	8000	Main Strea
4	Camera 03	3	IPDOME_MEGA200	10.16.6.126	8000	Main Strea
5	Camera 04	4	IPDOME_MEGA200	10.16.6.126	8000	Main Strea
6	Camera 05	5	IPDOME_MEGA200	10.16.6.126	8000	Main Strea
7	Camera 06	6	IPDOME_MEGA200	10.16.6.126	8000	Main Strea
8	Camera 07	7	IPDOME_MEGA200	10.16.6.126	8000	Main Strea
9	Camera 08	8	IPDOME_MEGA200	10.16.6.126	8000	Main Strea
10	Camera 09	9	IPDOME_MEGA200	10.16.6.126	8000	Main Strea
11	Camera 10	10	IPDOME_MEGA200	10.16.6.126	8000	Main Strea
12	Camera 11	11	IPDOME_MEGA200	10.16.6.126	8000	Main Strea

Total 21 Items << < 1/1 > >>

Figure 3-5 Manage Input Group

Step 4 You can modify the group information or delete the group by **Modify Group** and **Delete Group** access.

Managing Output Channel

Step 1 Enter the Device Management > Output Channel page.

Step 2 You can check the output channel information, or select an output channel from the list and edit the channel ID.

3.3 User and User-related Device Management

The default user account of the device is *admin* (administrator), and the password is set when you start the device for the first time. The *admin* user account has the permission to add and delete operator accounts and configure user parameters, and add the related devices for the added users.

You can configure 1 administrator and 15 operator accounts.

Step 1 On the System Management > User Management web page, click **Add** to enter the adding user interface.

Add User
✕

User Name ✔

User Type

Password ✔

Strong

8 characters allowed, and you can use a combination of numbers, lowercase and uppercase letters for your password with at least two kinds of them contained.

Confirm Password ✔

Select Linked Device					Select All
<input checked="" type="checkbox"/>	ID	Device Type	IP Address	Port No.	Device Model
<input checked="" type="checkbox"/>	1	IPC/IP Dome	10.16.6.126	8000	IPDOME_MEGA200
<input checked="" type="checkbox"/>	2	DVR/NVR	10.16.5.17	8000	DS-9016HUHI-F8/N
<input checked="" type="checkbox"/>	3	Decoder	10.12.1.249	8000	DS-6408HD-T
<input type="checkbox"/>					

Selected 3 Total 3 Items << < 1/1 > >>

Figure 3-6 Add User

Step 2 Edit the user name, enter password (strong password is highly recommended), and confirm the password.

WARNING

STRONG PASSWORD RECOMMENDED—We highly recommend that you create a strong password of your own choosing (using a minimum of 8 characters, including upper case letters, lower case letters, numbers, and special characters) in order to increase the security of your product. And we recommend that you reset your password regularly, especially in the high security system, resetting the password monthly or weekly can better protect your product.

Step 3 Select the linked device (s) from the list for the user.

Step 4 Click **OK** to save the settings.

Chapter 4 Keyboard Operation

Step 1 On the login interface, enter the user name and password to log in to the device.

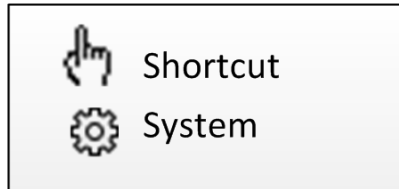

Figure 4-1 Menu

Step 2 Press the MODE button on the panel to enter the operation for different device.



Figure 4-2 Operation Mode Selection

Table 4-1 Description of Operation Mode

SN	Operation Mode	Description
1	Keyboard	The keyboard can be used for managing the devices (including the IPC, IP dome, DVR/NVR, MVC, decoder, video wall controller, etc.) for control. The keyboard can add the devices via Web browser and assign each of them the unique device ID, and finally manage to communicate with and realize the video wall or PTZ control through the <i>device ID+command</i> operation.
2	MAG by IP	The keyboard can connect with the matrix access gateway, and realize the video wall control, PTZ control, etc.
3	DVR by IP	The keyboard can connect with the DVR/NVR and remotely call the device menu and realize PTZ control through the virtual panel.
4	MAG by RS-422	The keyboard can connect with the matrix access gateway or MVC via RS-422 serial port, and realize the video wall control, PTZ control, etc.
5	DVR by RS-485	The keyboard can connect with the DVR/NVR via RS-485 serial port, and remotely call the device menu and realize PTZ control through the virtual panel.

6	Dome by RS-485	The keyboard can connect with the analog dome or PTZ unit via RS-485 serial port, and realize PTZ control.
---	----------------	--

Step 3 Use the joystick to select an operation mode and press **OK** button to enter the operation.

4.1 Keyboard Operation

The keyboard can be used for managing the devices (including the IPC, IP dome, DVR/NVR, MVC, decoder, video wall controller, etc.) for control.

4.1.1 Video Wall Control

Purpose:

You can select different window-division display modes for the selected output channel. The configurable multi-division display modes depend on the decoders, video wall controller, or Multi-function Video Center (MVC).



NOTE

The 1/2/4/6/8/9/12/16/25/32/36 window-division display modes are configurable.

Step 1 In the **Keyboard** operation mode, press the *Num + DEV* buttons on the keyboard panel to select the device ID (decoder, MVC and video wall controller).



NOTE

- When you enter no device ID (DEV), the first decoder (device ID: 1) is set for control by default. And if you enter no WIN ID, the window 01 is set to play the decoded video by default.
- The ID for the device (decoder and MVC) and input channel/input channel group can be viewed on the **Device Management>Device List**, and **Device Management>Input Channel** respectively via Web browser page. Please refer to Chapter 3.3.

Step 2 Press the *Num + MON* buttons to select the display window for the output channel.



NOTE

You should use the iVMS-4200 client software to select and drag the output channel to the corresponding display window on the video wall. Please refer to the user manual of the decoder or MVC for the details of video wall configuration and operation.

Step 3 Press the *Num + MULT* buttons to set the window-division display mode for the output channel.

Step 4 Press the *Num + WIN* buttons to set the sub-window to play the decoded video. The selected sub-window ID is shown in [ID] on the interface, e.g., [02].

Step 5 Press the *Num + CAM/CAM-G* buttons to select the input channel or input channel group. You can press the *PREV/NEXT* buttons to switch to the previous or next camera / camera group ID.

 **NOTE**

You can press the *0 + CAM* buttons to stop decoding of the current camera, or press the *0 + CAM-G* buttons to stop cycle decoding of the camera group.

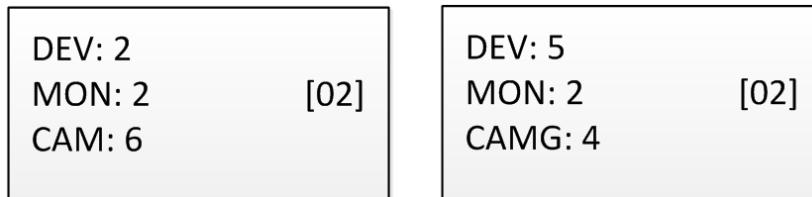

Figure 4-3 Video Wall Operation

Step 6 Operate the PTZ control on the video wall.

Move the joystick to realize pan/tilt movement in 8 directions and zoom in/out control.

Rotate the joystick in clockwise/anti-clockwise directions to I to realize the zoom in/out control.

The central button of the joystick can be used to capture picture.

 **NOTE**

You can also directly press the *Num + CAM* buttons or *Num + AUX* (set to screen jointing, refer to Chapter 4.1.4) and operate the PTZ control.

4.1.2 Preset/Patrol/Pattern Calling

The keyboard can be used to control the PTZ function of the connected IP dome camera, including the pan/tilt movement, zoom/iris/focus adjustment, and preset/patrol/pattern calling.

Step 1 In the **Keyboard** operation mode, press the *Num + MON* buttons to select the output channel ID.

Step 2 Press the *Num + CAM* buttons to select the input channel for PTZ control.

Step 3 Call the preset/patrol/pattern.

- Press the *Num + PRESET* buttons on the keyboard panel to call the defined preset.
- Press the *Num + PATROL* buttons on the keyboard panel to call the defined patrol.
- Press the *Num + PATTERN* buttons on the keyboard panel to call the defined pattern.

 **NOTE**

You can press *PATTERN* directly or *0 + PATTERN* to call the auto scanning.

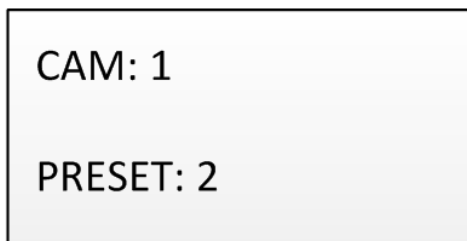

Figure 4-4 Preset Calling



The preset/patrol/pattern must be pre-configured.

4.1.3 Scene Calling

Purpose:

For the MVC, video wall controller, and decoder added to the keyboard, you can configure the scene via the iVMS 4200 client first and follow the steps below to switch the scene.

Step 1 In the **Keyboard** operation mode, press the *Num + DEV* buttons on the keyboard panel to select the device ID (decoder, MVC and video wall controller).

Step 2 Press the *Num + SCENE* buttons on the keyboard panel to switch to the defined scene.



The scene of the video wall must be pre-configured for the decoder or MVC via client software.

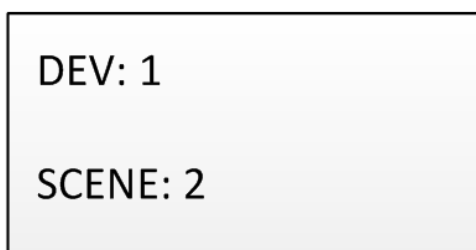

Figure 4-5 Scene Calling

4.1.4 AUX Functions

The keyboard is designed with AUX/F2 key on its panel. You are allowed to configure the AUX/F2 key to picture capture or screen jointing functions.

Screen Jointing of Video Wall

Step 1 Log in to the decoder or video wall controller via Web browser, and configure the video wall settings. Please refer to the user manual of decoder or video wall controller.

Step 2 Log in to keyboard via Web browser (<https://ip address>), and enter the Aux key settings page (System Management>Aux Key Settings).

Step 3 Set the Aux key function to **Screen Jointing**.

Step 4 Click **Save** to save the settings.

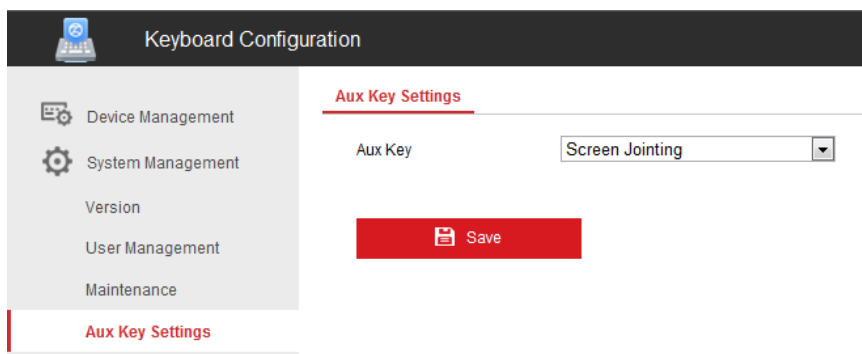

Figure 4-6 Aux Key Settings

Step 5 In the keyboard operation mode,

- 1) Press the *Num + DEV* buttons to select the device ID.
- 2) Press the *Num + AUX/F2* buttons to operate screen jointing for the video wall.
- 3) Press the *Num + CAM* buttons to select the input channel.



Figure 4-7 Video Wall Control by AUX Key

Picture Capture

The video picture from the camera can be captured and saved in U-flash disk through the keyboard operation.

Step 1 Log in to keyboard via Web browser (<https://ip address>), and enter the Aux key settings page (System Management>Aux Key Settings).

Step 2 Set the Aux key function to **Capture**.

Step 3 Click **Save** to save the settings.

Step 4 In the keyboard operation mode,

- 1) Press the *Num + DEV* buttons to select the device ID.

- 2) Press the *Num + MON* buttons to select the display window for the output channel.
- 3) Press the *Num + CAM* buttons to select the input channel.

Step 5 Press the *AUX/F2* button on the keyboard panel to capture the picture. The picture is saved in the U-flash disk in FAT32 format.

NOTE

You can also use the central button of the joystick to capture the picture in keyboard operation mode.

4.2 MAG by IP

The keyboard can connect with the matrix access gateway, and realize the video wall control, PTZ control, etc.

Step 1 Log in to the keyboard via Web browser (<https://ip> address), and enter the Matrix Access Gateway Settings page.

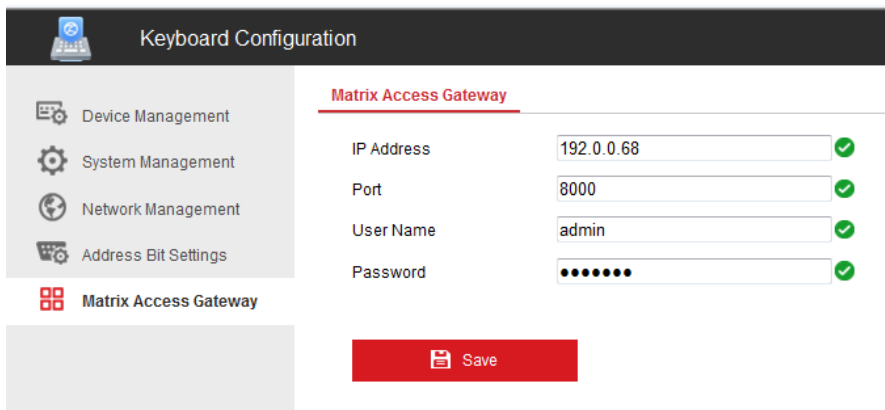

Figure 4-8 Matrix Access Gateway

Step 2 Configure the parameters of the matrix access gateway. And click **OK** to save the settings.

Step 3 Enter the **MAG by IP** operation mode on the keyboard.

Step 4 Press the *Num + MON* buttons to select the display window for the output channel.

Step 5 Press the *Num + WIN* buttons to set the window to play the decoded video.

Step 6 Press the *Num + CAM* buttons to select the input channel group. You can press the *PREV/NEXT* buttons to switch to the previous or next camera ID.

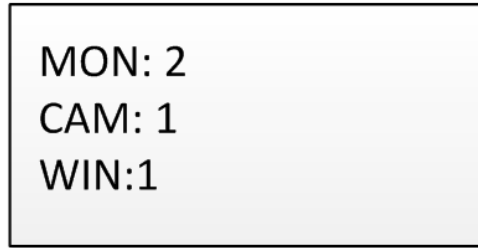

Figure 4-9 MAG by IP

NOTE

For the initial use of MAG/MVC, you must use the configuration kits software to configure the input/output channel ID of the MAG/MVC. Please refer to the user manual of MVC for details. The input/output channel ID is used for switching on the video wall or PTZ control during keyboard operation.

Step 7 Operate the PTZ control on the video wall. Refer to Step 6 in Chapter 4.1.1 for details.

4.3 DVR by IP

The keyboard can connect with the DVR/NVR and remotely call the device menu and realize PTZ control through the virtual panel.

Step 1 Log in to the keyboard via Web browser (<https://ip> address), and enter the DVR/NVR device list (Device Management>Device List>DVR/NVR).

Step 2 Click **Add** to add the DVR/NVR device. Please refer to Chapter 3.2 Device Management.

Channel No.	IP Address	Channel No.	Management Port	Security	Status	Protocol	Connect
D01	10.16.6.126	1	8000	Strong	Online	HIKVISION	

Figure 4-10 DVR/NVR Management

Step 3 Enter the **DVR by IP** operation mode on the keyboard.

Step 4 Press the *Num + DEV* buttons on the keyboard panel to select the device ID (viewed on the Device Management>Device List>DVR/NVR).

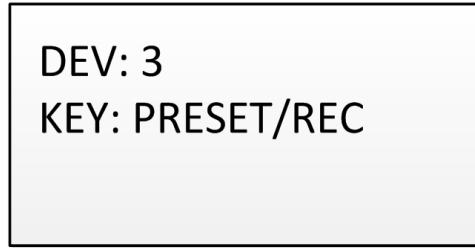

Figure 4-11 DVR by IP

Step 5 Operate the buttons on the keyboard panel to realize the corresponding functions. Please refer to *Chapter 1.4 Functional Buttons* to check the description of the DVR control buttons.

4.4 MAG by RS-422

The keyboard can connect with the matrix access gateway or MVC via RS-422 serial port, and realize the video wall control, PTZ control, etc.

Before you start:

Check the connection between the MAG and the Keyboard. The **T+** and **T-** terminals of the keyboard's RS-422 serial port must be connected with the **D+** and **D-** terminals of the MAG's RS-422 serial port.

Refer to the following figure:

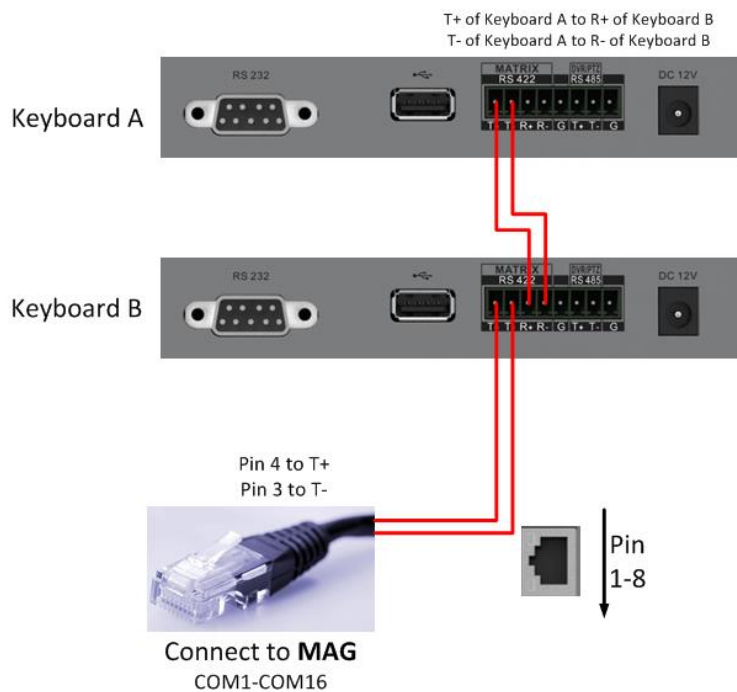

Figure 4-12 Connection between Cascaded Keyboards and MAG

Refer to the following figure as an example for the network cable (568B). The pin 3 and pin 4 are colored in green-white and blue.

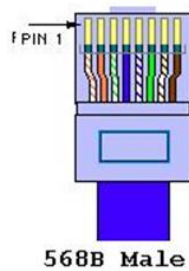

Figure 4-13 Network Cable

Step 1 Enter the **MAG by RS-422** operation mode on the keyboard.

Step 2 Press the *Num + MON* buttons to select the display window for the output channel.

Step 3 Press the *Num + WIN* buttons to set the window to play the decoded video.

Step 4 Press the *Num + CAM* buttons to select the input channel.

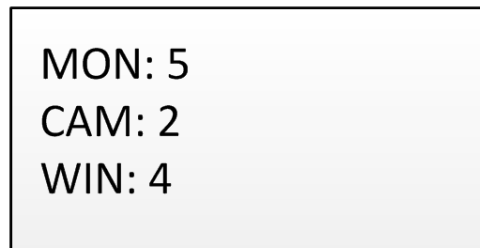

Figure 4-14 Matrix Operation

Step 5 You can operate the PTZ control on the video wall for the connected dome. Refer to Chapter 4.1.2 for instructions.

NOTE

You can also press the *Num + CAM* buttons to select the input channel, and operate the PTZ control.

NOTE

- Both the MAG and MVC can be connected to the keyboard by RS-422 serial port.
- For the initial use of MAG/MVC, you must use the configuration kits software to configure the input/output channel ID of the MAG/MVC. Please refer to the user manual of MVC for details. The input/output channel ID is used for switching on the video wall or PTZ control during keyboard operation.

4.5 DVR by RS-485

The keyboard can connect with the DVR/NVR via RS-485 serial port, and remotely call the device menu and realize PTZ control through the virtual panel.

Before you start:

Check the connection between the DVR/NVR and the Keyboard. The **T+** and **T-** terminals of the keyboard's RS-485 serial port must be connected with the **D+** and **D-** terminals of the KB port on the DVR rear panel respectively.

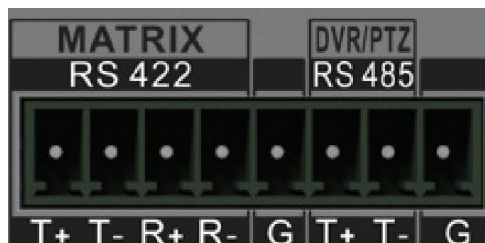

Figure 4-15 RS-485 Serial Port

Step 1 Use the ClientDemo to log in to the DVR/NVR to check the remote control ID.

Step 2 Enter the **DVR by RS-485** operation mode on the keyboard.

Step 3 Press the *Num + DEV* buttons on the keyboard panel to select the device ID (corresponding to the remote ID on ClientDemo).

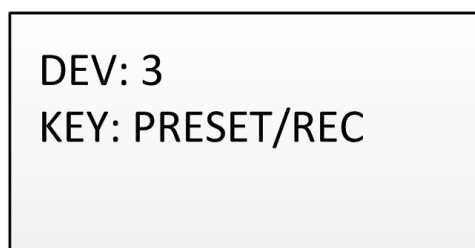

Figure 4-16 DVR by RS-485

Step 4 Move the joystick and operate the buttons on the keyboard panel to realize the corresponding functions. Please refer to *Chapter 1.4 Functional Buttons* to check the description of the DVR control buttons.

 **NOTE**

The baud rate, protocol and other parameters of RS-485 of the keyboard must be configured to 9600, 8, 1 and none parity.

4.6 Dome by RS-485

The keyboard can connect with the analog dome or PTZ unit via RS-485 serial port, and realize PTZ control.

Before you start:

Check the connection between the dome and the Keyboard. The **T+** and **T-** terminals of the keyboard's RS-485 serial port must be connected with the **T+** and **T-** terminals of the dome respectively.

Step 1 Enter the **Dome by RS-485** operation mode on the keyboard.

Step 2 Press the *Num + CAM* buttons to select the dome site.

Step 3 Use the joystick and operate the buttons on the keyboard panel to realize the corresponding functions. Please refer to *Chapter 1.4 Functional Buttons* to check the description of the PTZ control buttons.



Figure 4-17 DVR by RS-485



NOTE

The address, baud rate, protocol and other parameters of RS-485 must be configured the same with the dome's RS-485 parameters.

4.7 Shortcut Operation

The device control via keyboard can be realized by shortcut operation.

Step 1 On the login interface, enter the user name and password to log in to the device.

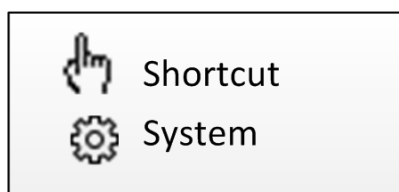

Figure 4-18 Menu

Step 2 Use the joystick to select the **Shortcut** to enter the shortcut operation mode.

Step 3 Press the *Num+DEV/MON/CAM/CAM-G/PRESET/PATROL/PATTERN/WIN/MULT/SCENE* on the keyboard buttons to realize the corresponding device operation and control.

Chapter 5 System Menu Configuration

On the main menu after login, you can select **System** to check the version, and configure the system configuration, including network, user, RS-485, RS-422, hardware, time and maintenance.

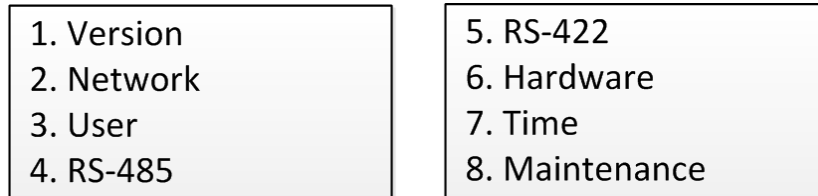

Figure 5-1 Main Menu



NOTE

Refer to Chapter 3.1 Network Settings for the configuration of network parameters.

5.2 Version

Select **Version** to check the version information of the keyboard, including the firmware, panel, hardware and software version.

5.3 User Management

Select **User** to enter the user management interface. You can change the password (admin), add new user, edit user or delete the user.

Click **OK** button or the central button of joystick to save the settings.

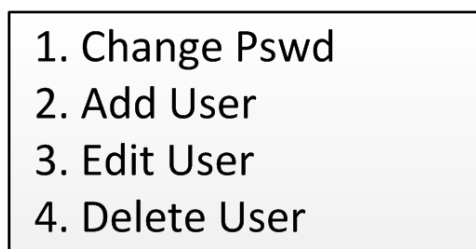

Figure 5-2 User Management



NOTE

Only the admin user is allowed to add/edit/user the user (operator).

5.4 RS-485/RS-422 Settings

You can connect the analog dome or DVR with the keyboard via RS-484 serial port, and the MVC/MAG with keyboard via RS-422 serial port.

Select **RS-485/RS-422** to enter the RS-485/RS-422 settings interface. You can configure the address bit (RS-485 only), baud rate, data bit, protocol (PROT: PELCO-P, PELCO-D, VICON, KALATEL, HIKVISION selectable), stop bit, parity, and copy all settings. When you set the Copy All to Yes for RS-485 serial port, the current settings will be copied to the connection of all other RS-485 devices.

Click **OK** button or the central button of joystick to save the settings.

Add. Bit: 0 Baud Rate: 9600 Data Bit: 8 PROT: PELCO-P	123	Stop Bit: 0 Parity: None Copy All: No
--	-----	---

Figure 5-3 RS-485 Settings



NOTE

The RS-485/RS-422 parameters configured here must be the same with the connected dome/DVR or MVC/MAG.

5.5 Hardware

You can set the auto-logoff feature of the keyboard.

Select **Hardware** to enter the following interface, and move (left/right) the joystick to set the **A-Logoff** to ON or OFF. Click **OK** button or the central button of joystick to save the settings.

When the auto-logoff is set to ON, the system will automatically log off after the device is not operated for 30 minutes.

A-Logoff: ON

Figure 5-4 Auto-Logoff Settings

5.6 Time Settings

Select **Time** to enter the system time settings interface. You can set the value of year, month, date, time format, hour, minute and second. Click **OK** button or the central button of joystick to save the settings.

5.7 Maintenance

Select **Maintenance** to enter the system maintenance settings interface. You can upgrade the device, import and export the configuration files, and recover the device to the factory default settings.

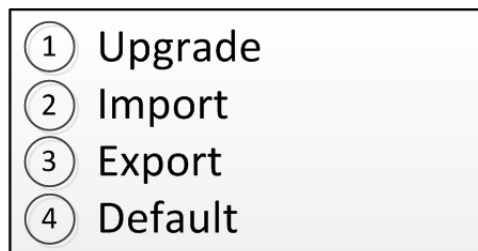

Figure 5-5 Maintenance

NOTE

- You should connect the U-flash disk to the keyboard before upgrading, and importing/exporting the files.
- The upgrade file and configuration file must be located in the root directory of the U-flash disk.
- The upgrade file must be in *digicap.dav*; and the configuration file in *kbCfg.bin*.

Chapter 6 Specifications

Table 6-1 Specification of DS-1200KI

Model		DS-1200KI
System	LCD screen	128 x 64 pixel screen
	Joystick	4-axis joystick
	Control mode	Network, RS-232, RS-422, RS-485
External Interfaces	Network interface	1; 10 M/100 Mbps self-adaptive Ethernet interface
	Serial interface	1 RS-232, 1 RS-422, 1 RS-485
	USB interface	1 × USB 2.0
General	Power supply	12 VDC
	Consumption	≤ 4.5 W
	Working temperature	-10 to +55° C (14 to 131° F)
	Working humidity	10% to 90%
	Dimensions (W × D × H)	435 × 193 × 110 mm (17.1 × 7.6 × 4.3 inch)
	Weight	≤ 1 kg (2.2 lb)

Table 6-2 Specification of DS-1006KI

Model		DS-1006KI
System	LCD screen	128 x 64 pixel screen
	Joystick	4-axis joystick
	Control mode	RS-232, RS-422, RS-485
External Interfaces	Serial interface	1 RS-232, 1 RS-422, 1 RS-485
	USB interface	1 × USB 2.0
General	Power supply	12 VDC
	Consumption	≤ 4.5 W
	Working temperature	-10 to +55° C (14 to 131° F)
	Working humidity	10% to 90%
	Dimensions (W × D × H)	435 × 193 × 110 mm (17.1 × 7.6 × 4.3 inch)
	Weight	≤ 1 kg (2.2 lb)

